

606 СЕРИЯ



606
СЕРИЯ



Техническая спецификация:

Диапазон температур:

-20°C +100 °C (-4°F +250F)

Рабочее давление:

0 - 10 бар (0 - 145 PSI)

Проток:

63-110 мм

NW - 606.25

NW - 606.33

NW - 606/50

Стандартная версия:

Полный проток

Хромирование

Прокладка Нитрил NBR

Опции

Нержавеющая сталь

Прокладки этилен пропиленовый каучук (EPDM)

Прокладки Фторуглерод (FPM)

Материал

Корпус муфты: Хромированная латунь

Задняя часть: латунь с никелевым покрытием

Втулка: хромированная латунь

Пружины: Нержавеющая сталь

Пружинное кольцо: Нержавеющая сталь

Шарики: Нержавеющая сталь

Прокладки: Нитрил NBR

Ниппель: Нержавеющая сталь AISI - 420

Область применения:

- В системах регулирования температуры с горячей или холодной водой, маслом и т. Д.
- На паропроводе
- Промышленное литье под давлением

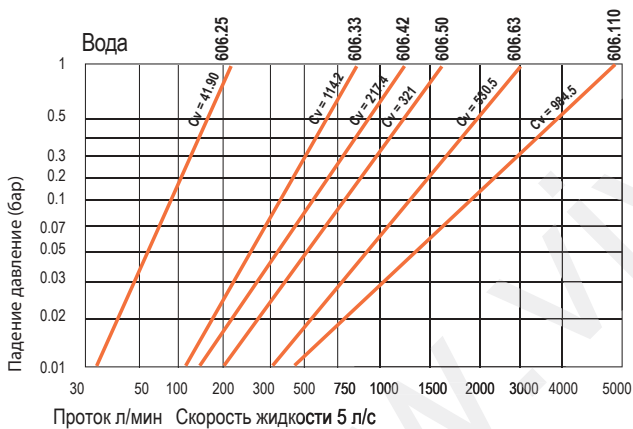

Муфта с внутренней резьбой

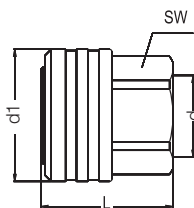

←→←→	d	d1	SW	L
Артикул Order No				
606.25 DG 33	BSP 1"	57	41	57
606.33 DG 42	BSP 1.1/4"	65	50	62
606.50 DG 60	BSP 2"	89	70	70

Ниппель с внутренней резьбой

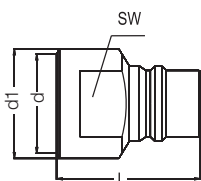

←→←→	d	d1	SW	L
Артикул Order No				
606.25 DR 33	BSP 1"	45	41	61
606.33 DR 42	BSP 1.1/4"	55	50	66
606.50 DR 60	BSP 2"	75	71	78

Адаптер под шланг с внешней резьбой
(хромированная латунь)

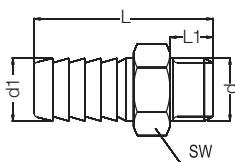

←→←→	d	L1	d1	SW	L
Артикул Order No					
606.25 SHR 33	BSP 1"	19	35	40	70
606.33 SHR 42	BSP 1.1/4"	21	43	50	69
606.50 SHR 60	BSP 2"	25	55	70	85

Адаптер с двухсторонней внешней резьбой
папа/папа
(хромированная латунь)

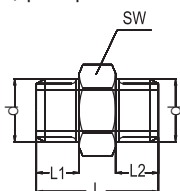

←→←→	d	SW	L1	L2
Артикул Order No				
606.25 NP 33	BSP 1"	50	19	19
606.33 NP 42	BSP 1.1/4"	52	21	21
606.50 NP 60	BSP 2"	65	25	25

Ниппель глухой
(защитный колпачек для муфты)

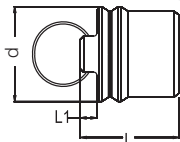

←→←→	d	L1	L2
Артикул Order No			
606.25 KG 33	34	41	10
606.33 KG 42	42	46	10
606.50 KG 60	60	55	10

601 СЕРИЯ





Техническая спецификация / Technical Specifications

Диапазон температур / Temperature Range

-20°C +100°C (-5°F +210°F) Прокладка Нитрил NBR (N)

-10°C +180°C (+15°F +356°F) Прокладки фторкаучук FPM (V)

Рабочее давление / Working Pressure

601.06	16 бар (232 PSI)
601.09	16 бар (232 PSI)
601.12	16 бар (232 PSI)
601.16	16 бар (232 PSI)
601.20	16 бар (232 PSI)
601.25	16 бар (232 PSI)
601.38	16 бар (232 PSI)

Проток / Flow Size

601.06	6 мм
601.09	9 мм
601.12	12 мм
601.16	16 мм
601.20	20 мм
601.25	25 мм
601.38	38 мм

Материал / Material

Корпус муфты / Socket Body : Латунь / Brass

Втулка / Sleeve: Нержавеющая сталь AISI 420 с хромированным покрытием AISI 420 Chroma plated

Клапан / Valve : Латунь / Brass

Пружины / Springs : Нержавеющая сталь
Stainless Steel

Прокладки / Seals : Уплотнительное кольцо из витона / FPM (V)

Ниппель / Plugs :

601.06 / 601.09 / 601.12 Латунь / Brass

601.16 / 601.20 / 601.25 / 601.38 Psl. Нержавеющая сталь / Stainless Steel

Опции / Options

Нержавеющая сталь / Stainless Steel

Прокладки этилен пропиленый каучук (EPDM) / EPDM Seal

Прокладки перфторкаучук (FFKM) / FFKM Seal

Цветовое кодирование / Colour Coding

Область применения:

- В системах регулирования температуры с горячей или холодной водой, маслом и т. Д.
- На паропроводе
- Промышленное литье под давлением

Using Area

- On temperature regulation applications with hot or cold water, oil etc
- Injection moulding industries
- On steam line

График зависимости протока от падения давления
Flow Rate vs Pressure Drop Graph

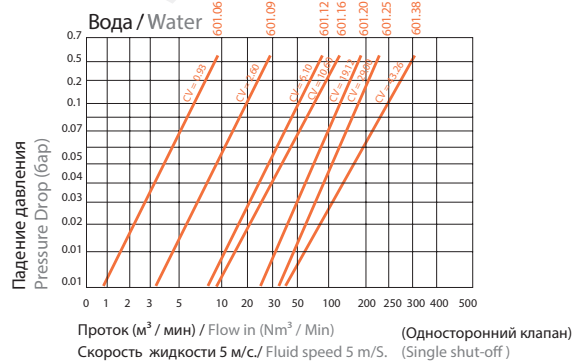
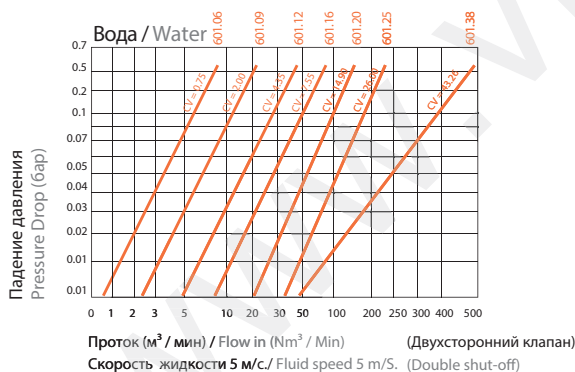

601 СЕРИЯ

Муфта под шланг / Hose Tail Socket

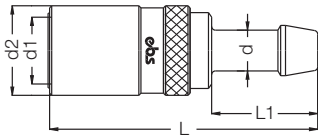

→→○	→←←	d	d2	d1	L	L1
Артикул Order No	Артикул Order No					
601.06 HGB 08	601.06 HG 08	08	19	9.5	60	23
601.09 HGB 12	601.09 HG 12	12	25	14	69.5	28
601.12 HGB 13	601.12 HG 13	13	31	18	82	28
601.12 HGB 16	601.12 HG 16	16	31	18	82	28
601.16 HGB 16	601.16 HG 16	16	32	22.5	109	28
601.16 HGB 19	601.16 HG 19	19	38	22.5	114	33

Муфта под шланг с безхомутвым соединением / Hose Clamp Socket

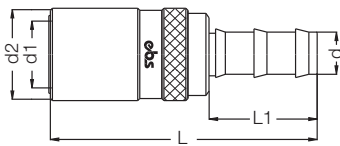

→→○	→←←	d	d2	d1	L	L1
Артикул Order No	Артикул Order No					
601.06 FGB 10	601.06 FG 10	10	19	9.5	60	24
601.09 FGB 10	601.09 FG 10	10	25	14	69.5	24
601.09 FGB 13	601.09 FG 13	13	25	18	69.5	28
601.12 FGB 13	601.12 FG 13	13	31	18	92	38
601.16 FGB 16	601.16 FG 16	16	38	22.5	109	38
601.16 FGB 19	601.16 FG 19	19	38	22.5	109	38

Муфта 90° под шланг / 90° Hose Tail Socket

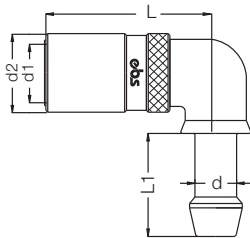

→→○	→←←	d	d2	d1	L	L1
Артикул Order No	Артикул Order No					
601.06 HGB 08-90°	601.06 HG 08-90°	08	19	9.5	59	23
601.09 HGB 10-90°	601.09 HG 10-90°	10	25	14	60	28
601.09 HGB 12-90°	601.09 HG 12-90°	12	25	14	65	28
601.12 HGB 16-90°	601.12 HG 16-90°	16	31	18	82	28
601.16 HGB 19-90°	601.16 HG 19-90°	19	38	22.5	132	60

Муфта 45° под шланг / 45° Hose Tail Socket

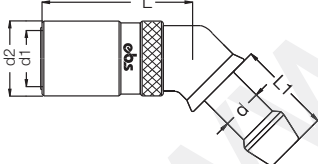

→→○	→←←	d	d2	d1	L	L1
Артикул Order No	Артикул Order No					
601.06 HGB 08-45°	601.06 HG 08-45°	08	19	9.5	59	23

Муфта с внутренней резьбой / Female Thread Socket

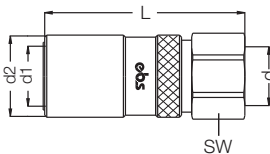

→→○	→←←	d	d2	d2	L	SW
Артикул Order No	Артикул Order No					
601.06 DGB 13	601.06 DG 13	BSP 1/4"	19	9.5	46	17
601.06 DGB N13	601.06 DG N13	NPT 1/4"	19	9.5	46	17
601.09 DGB 17	601.09 DG 17	BSP 3/8"	25	14	53	22
601.09 DGB N17	601.09 DG N17	NPT 3/8"	25	14	53	22
601.12 DGB 21	601.12 DG 21	BSP 1/2"	31	18	67	27
601.12 DGB N21	601.12 DG N21	NPT 1/2"	31	18	67	27
601.16 DGB 26	601.16 DG 26	BSP 3/4"	38	22.5	90	35
601.16 DGB N26	601.16 DG N26	NPT 3/4"	38	22.5	90	35

Муфта 90° с внутренней резьбой / 90° Female Thread Socket

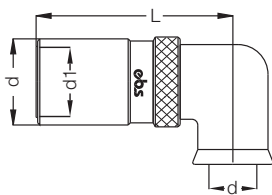

←→⊕	←→←	d	d1	L
Артикул Order No	Артикул Order No			
601.06 DGB 13-90°	601.06 DG 13-90°	BSP 1/4"	19	59
601.06 DGB N13-90°	601.06 DG N13-90°	NTP 1/4"	19	59
601.09 DGB 17-90°	601.09 DG 17-90°	BSP 3/8"	25	65
601.09 DGB N17-90°	601.09 DG N17-90°	NTP 3/8"	25	65
601.12 DGB 21-90°	601.12 DG 21-90°	BSP 1/2"	31	82
601.12 DGB N21-90°	601.12 DG N21-90°	NTP 1/2"	31	82

Муфта 45° с внутренней резьбой / 45° Female Thread Socket

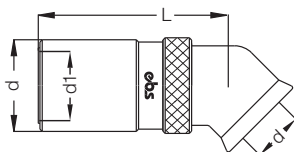

←→⊕	←→←	d	d1	L
Артикул Order No	Артикул Order No			
601.06 DGB 13-45°	601.06 DG 13-45°	BSP 1/4"	19	59

Муфта прямая с внешней резьбой / Male Socket

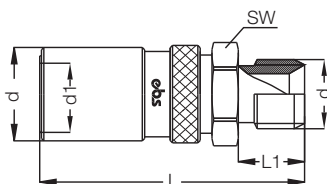

←→⊕	←→←	d	d1	L	L1	SW
Артикул Order No	Артикул Order No					
601.06 EGB 13	601.06 EG 13	BSP 1/4"	19	55	10	17
601.09 EGB 17	601.09 EG 17	BSP 3/8"	25	61	11	22
601.12 EGB 21	601.12 EG 21	BSP 1/2"	31	72	14	27
601.16 EGB 26	601.16 EG 26	BSP 3/4"	38	115.5	14	32

Муфта 90° с внешней резьбой / 90° Male Socket

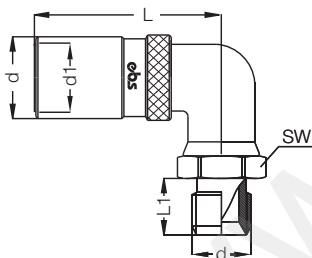

←→⊕	←→←	d	d1	L	L1	SW
Артикул Order No	Артикул Order No					
601.06 EGB 13-90°	601.06 EG 13-90°	BSP 1/4"	19	55	10	17
601.09 EGB 17-90°	601.09 EG 17-90°	BSP 3/8"	25	61	11	22
601.12 EGB 21-90°	601.12 EG 21-90°	BSP 1/2"	31	72	14	27
601.16 EGB 26-90°	601.16 EG 26-90°	BSP 3/4"	38	115.5	14	32

Ниппель с внутренним шестигранником под ключ / Internal Hex Male Plug

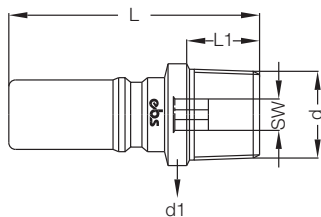

←→←	d	d1	L	L1	SW
Артикул Order No					
601.06 ER 10	BSPT 1/8"	10	31	7.5	5
601.06 ER 13	BSPT 1/4"	13	35	13	5
601.06 ER N10	NPT 1/8"	10	31	10	5
601.06 ER N13	NPT 1/4"	13	35	13	5
601.09 ER 13	BSPT 1/4"	13	34	10	8
601.09 ER 17	BSPT 3/8"	17	36	11	8
601.09 ER N13	NPT 1/4"	13	34	11	8
601.09 ER N17	NPT 3/8"	17	36	11	8
601.12 ER 17	BSPT 3/8"	17	39	13	10

601 СЕРИЯ

Ниппель с внешней резьбой / Male Plugs

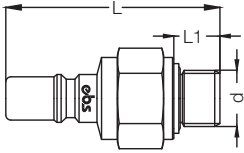

→↔← Артикул Order No	d	L	L1	SW
601.06 RRB 10	BSPT 1/8"	45	7	17
601.06 RRB 13	BSPT 1/4"	45	9	17
601.09 RRB 13	BSPT 1/4"	51	9	19
601.09 RRB 17	BSPT 3/8"	48	10	20
601.12 RRB 17	BSPT 3/8"	63.5	10	24
601.12 RRB 21	BSPT 1/2"	62	12	24
601.16 RRB 26	BSPT 3/4"	81	14	32

Ниппель с внешней резьбой / Male Plugs

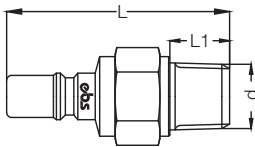

→↔← Артикул Order No	d	L	L1	SW
601.06 ERB N10	NPT 1/8"	45	10	17
601.06 ERB N13	NPT 1/4"	45	11	17
601.09 ERB N13	NPT 1/4"	52	13	19
601.09 ERB N17	NPT 3/8"	48.5	13	19
601.12 ERB N17	NPT 3/8"	62	13	24
601.12 ERB N21	NPT 1/2"	62	15	24
601.16 ERB N26	NPT 3/4"	81	19	32

Ниппель с внешней резьбой / Male Plugs

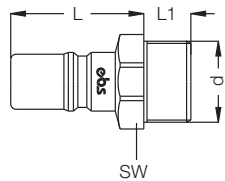

→↔← Артикул Order No	d	L	L1	SW
601.06 ERB 17	BSP 3/8"	26	10	19
601.09 ERB 21	BSP 1/2"	25	12	22
601.12 ERB 26	BSP 3/4"	30	16	27
601.16 ERB 33	BSP 1"	38	24	32

Ниппель с внутренней резьбой / Female Plugs

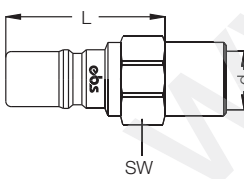

→↔← Артикул Order No	d	L	SW
601.06 DRB 13	BSP 1/4"	47	17
601.06 DRB N13	NPT 1/4"	47	17
601.09 DRB 13	BSP 1/4"	48.5	19
601.09 DRB N13	NPT 1/4"	48.5	19
601.12 DRB 17	BSP 3/8"	49	22
601.12 DRB N21	NPT 1/2"	85	27
601.16 DRB 26	BSP 3/4"	81	32
601.16 DRB N26	NPT 3/4"	81	32

Ниппель с наружной резьбой / Female Plugs

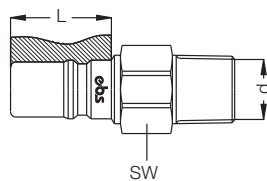

→↔← Артикул Order No	d	L	SW
601.06 DRB	06	17.5	17
601.09 DRB	09	18.5	19
601.12 DRB	12	23	24
601.16 DRB	16	30	32

Ниппель с наружной резьбой / Male Plugs

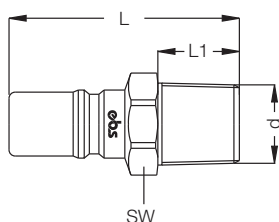

←→←→	d	L	L1	SW
Артикул Order No				
601.06 ER 21	BSPT 1/2"	41	13	24
601.09 ER N17	NPT 3/8"	44	16	22
601.12 ER N21	NPT 1/2"	44	16	27
601.16 ER 21	BSPT 1/2"	63	16.5	22
601.16 ER 26	BSPT 3/4"	63	16.5	27

Ниппель с наружной резьбой / Male Plugs

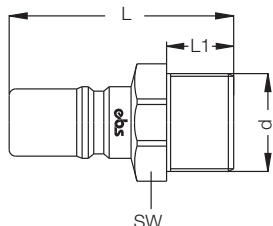

←→←→	d	L	L1	SW
Артикул Order No				
601.06 ER 21	BSP 1/2"	41	13	22
601.12 ER 26	BSP 3/4"	63	16	27
601.16 ER 33	BSP 1"	63	16	35
601.16 ER M24	M24x1.5	63	16	27

Ниппель с внутренней резьбой / Female Plugs

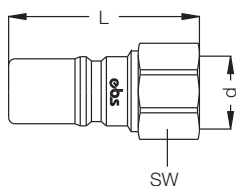

←→←→	d	L	SW
Артикул Order No			
601.06 DR 13	BSP 1/4"	34	17
601.06 DR N13	NPT 1/4"	47	17
601.09 DR 17	BSP 3/8"	37	22
601.09 DR N17	NPT 3/8"	38	22
601.12 DR 21	BSP 1/2"	45	27
601.12 DR N21	NPT 1/2"	67	27
601.16 DR 26	BSP 3/4"	58	32
601.16 DR N26	NPT 3/4"	80	32

Ниппель под шланг / Hose Plugs

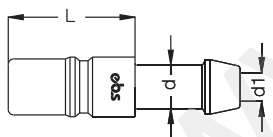

←→←→	d	d1	L
Артикул Order No			
601.06 HR 08	5/16"	08	24.5
601.09 HR 12	15/32"	12	53
601.12 HR 16	5/8"	16	30
601.16 HR 19	3/4"	19	37

Ниппель с наружной резьбой / Male Plugs

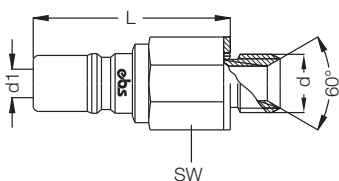

←→←→	d	d1	L	SW
Артикул Order No				
601.06 ORB 10	BSP 1/8"	10	38	17
601.06 ORB 13	BSP 1/4"	13	36	17
601.06 ORB 13	BSP 1/4"	13	38	19
601.06 ORB 17	BSP 3/8"	17	38	20
601.06 ORB 17	BSP 3/8"	17	53.5	24
601.06 ORB 21	BSP 1/2"	21	50	24
601.06 ORB 26	BSP 3/4"	26	67	32

601 СЕРИЯ

Муфта с внутренней резьбой / Female Thread Socket

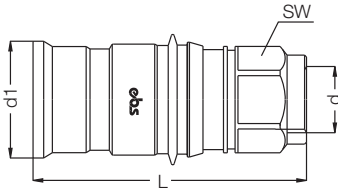

→↔←	d	d1	L	SW
Артикул Order No				
601.20 DGB 26	BSP 3/4"	53	119.5	42
601.20 DGB 33	BSP 1"	53	119.5	42
601.20 DGB 26	NPT 3/4"	53	119.5	42
601.20 DGB 33	NPT 1"	53	119.5	42
601.25 DGB 33	BSP 1"	60	140	50
601.25 DGB 42	BSP 1"1/4	60	140	50
601.38 DGB 48	BSP 1"1/2	82	158	70
601.38 DGB 60	BSP 2"	82	158	70

Муфта с наружной резьбой / Male Thread Socket

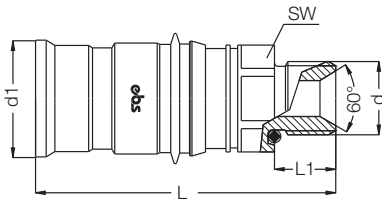

→↔←	d	d1	L	L1	SW
Артикул Order No					
601.20 EGB 33	BSP 1"	53	132	20	42
601.25 EGB 33	BSP 1"	60	144	20	50
601.25 EGB 42	BSP 1"1/4	60	144	21	50
601.38 EGB 48	BSP 1"1/2	80	167	24	70
601.38 EGB 60	BSP 2"	80	171	25	70

Муфта с наружной резьбой / Male Thread Socket

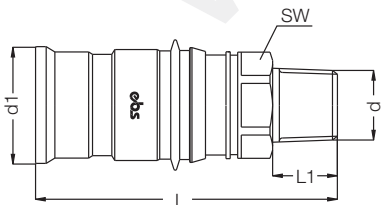

→↔←	d	d1	L	L1	SW
Артикул Order No					
601.20 EGB N33	NPT 1"	53	132	20	42
601.25 EGB N33	NPT 1"	60	144	20	50
601.25 EGB N42	NPT 1"1/4	60	148.5	24.5	50
601.38 EGB N48	NPT 1"1/2	82	167	24.5	70
601.38 EGB N60	NPT 2"	82	167	24.5	70

Ниппель с внутренним шестигранником / Internal Hex Male Plug

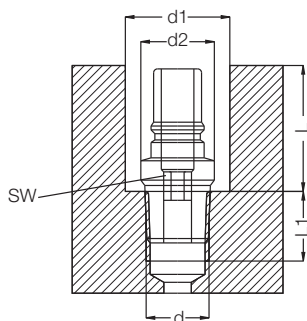

Артикул Order No	d	d1	d2	L	L1	SW
601.06 RR 10	BSPT 1/8"	20	10	26	9	5
601.06 RR 13	BSPT 1/4"	20	14	27	12	5
601.09 RR 13	BSPT 1/4"	26	14	26	12	8
601.09 RR 17	BSPT 3/8"	26	17	28	13	8
601.12 RR 17	BSPT 3/8"	33	18	31	13	10
601.06 TR 10	NPT 1/8"	20	11	28	9	5
601.06 TR 13	NPT 1/4"	20	14	27	13	5
601.09 TR 13	NPT 1/4"	26	14	26	13	8
601.09 TR 17	NPT 3/8"	26	17	28	13	8

Ниппель с внешней резьбой / Male Plugs

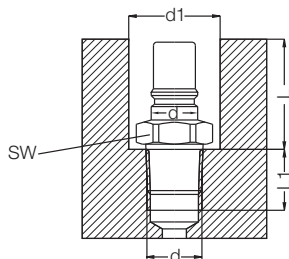

Артикул Order No	d	d1	L	L1	SW
601.12 TR 17	NPT 3/8"	36	29	11	24
601.12 RR 21	BSPT 1/2"	33	29	15	22
601.12 TR 21	NPT 1/2"	33	29	15	22
601.12 RR 26	BSPT 3/4"	40	47	19	27

Ниппель с внешней резьбой / Female Plugs

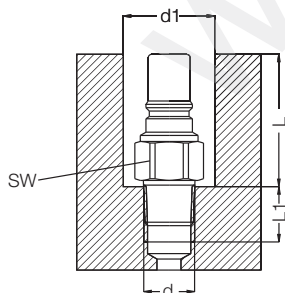

Артикул Order No	d	d1	L	L1	SW
601.06 RRB 10	BSPT 1/8"	26	33	9	17
601.06 RRB 13	BSPT 1/4"	26	33	12	17
601.09 RRB 13	BSPT 1/4"	29	38.5	12	19
601.09 RRB 17	BSPT 3/8"	29	38.5	13	20
601.12 RRB 17	BSPT 3/8"	36	46.5	13	24
601.12 RRB 21	BSPT 1/2"	36	46.5	15	24
601.16 RRB 26	BSPT 3/4"	46	67	16	32
601.06 TRB 10	NPT 1/8"	26	33	9	17
601.06 TRB 13	NPT 1/4"	26	33	12	17
601.09 TRB 13	NPT 1/4"	29	38.5	12	19
601.09 TRB 17	NPT 3/8"	29	38.5	13	20
601.12 TRB 17	NPT 3/8"	36	46.5	13	24
601.12 TRB 21	NPT 1/2"	36	46.5	15	24
601.16 TRB 26	NPT 3/4"	46	67	16	32

601 СЕРИЯ

Ниппель с внутренней резьбой / Female Plugs

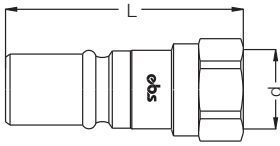

 Артикул Order No	d	L	SW
601.20 DR 33	BSP 1"	92	41
601.25 DR 33	BSP 1"	100	41
601.38 DR 48	BSP 1 1/2"	110	65

Ниппель с внутренней резьбой / Female Plugs

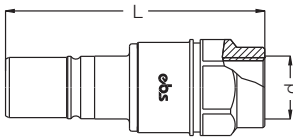

 Артикул Order No	d	L	SW
601.20 DRB 26	BSP 3/4"	126.5	42
601.20 DRB 33	BSP 1"	126.5	42
601.20 NRB 33	NPT 1"	126.5	42
601.25 DRB 33	BSP 1"	148.5	50
601.25 DRB 42	BSP 1 1/4"	158	50
601.38 DRB 48	BSP 1 1/2"	156	70
601.38 DRB 60	BSP 2"	156	70

Ниппель с внешней резьбой / Male Plugs

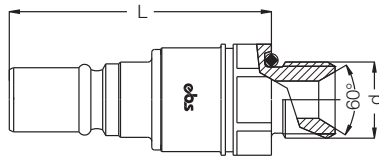

 Артикул Order No	d	L	SW
601.20 ERB 33	BSP 1"	120	42
601.25 ERB 33	BSP 1"	127	50
601.25 ERB 42	BSP 1 1/4"	131.5	50
601.38 ERB 48	BSP 1 1/2"	156	70
601.38 ERB 60	BSP 2"	161	70

Ниппель с внешней резьбой / Male Plugs

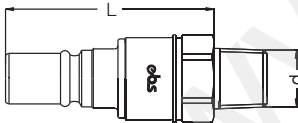

 Артикул Order No	d	L	SW
601.20 ERB N33	NPT 1"	120	42
601.25 ERB N33	NPT 1"	127	50
601.25 ERB N42	NPT 1 1/4"	131.5	50
601.38 ERB N48	NPT 1 1/2"	156	70
601.38 ERB N60	NPT 2"	161	70

Ниппель с внешней резьбой / Male Plugs

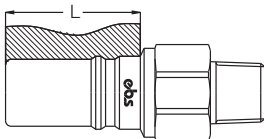

Артикул Order No	L
601.20	60
601.25	72.5
601.38	75